

WIRE WOUND HIGH FREQUENCY CERAMIC CHIP INDUCTOR

绕线式高频陶瓷电感



PWCI SERIES



深圳高路瑞电子有限公司

Shenzhen Glory Electronics Co., Ltd.

Tel: 0755-2342 5572

FAX: 158 8976 3756

Website: [www.gloryelectr.com](http://www.gloryelectr.com)

E-mail: [glory@gloryelectr.com](mailto:glory@gloryelectr.com)

# Wire Wound High Frequency Ceramic Chip Inductor-PWCI Series

## 绕线式高频陶瓷电感-PWCI 系列



### INTRODUCTION AND CHARACTERISTICS 产品介绍及特性

INTRODUCTION	产品介绍
--------------	------

◆ The PWCI is the chip inductors of a wire wound type widely used in the communication applications, such as cellular phones, television tuners, radios, and other electronic devices. The features of wire wound are higher self-resonate frequency, better Q factor, and much stable performance.

◆ PWCI 系列高频绕线电感广泛应用于通讯产品中，例如手机，电视调谐器，收音机和其他电子设备。绕线有高的共振频率、良好的品质因数和稳定的电气特性。

CHARACTERISTICS	特性
-----------------	----

- ◆ Minature size, suitable for SMT
- ◆ High Q value and high self-resonate frequency with ceramic material
- ◆ Using terminal electrode structure to restrain the parasitic component effect quite caused by lead
- ◆ Excellent in solderability and heat resistance

- ◆ 尺寸小，适合高密度表面贴装
- ◆ 陶瓷材料具有高 Q 值、高共振频率
- ◆ 采用端电极结构，很好的抑制引线引起的寄生元件效应，具有高的可靠性
- ◆ 良好的焊接性和耐焊性

APPLICATIONS	应用产品
--------------	------

- ◆ Portable communication equipment and PDA
- ◆ Bluetooth, W-LAN, Broadband network
- ◆ High speed electronic device
- ◆ Used for radiation high speed noise suppression
- ◆ Mobile phones such as GSM, CDMA, PDC, etc.

- ◆ 移动通信、PDA
- ◆ 蓝牙、无线网、宽带网
- ◆ 高频回路
- ◆ 抑制各种高频杂波
- ◆ 移动电话如 GSM/CDMA/PDC 等制式

**PRODUCT IDENTIFICATION 产品型号**

**PWCI 1005 H 1N2 □ T**  
 ①      ②      ③      ④      ⑤      ⑥

① Product Series Code 产品系列码	PWCI	Wire Wound High Frequency Ceramic Chip Inductor 绕线式高频陶瓷电感
② Size Code 尺寸码	1005	长×宽 (L×W) (mm) 1.0×0.5
③ Material Code 材质代号	H	高频材料
④ Inductance Value Code 感量值	1N2	1.2nH
	R12	120nH
⑤ Inductance Tolerance 电感值公差	B	±0.1nH
	C	±0.2nH
	S	±0.3nH
	D	±0.5nH
	G	±2%
	H	±3%
	J	±5%
⑥ Packing 包装形式	T	Tape and Reel 编带

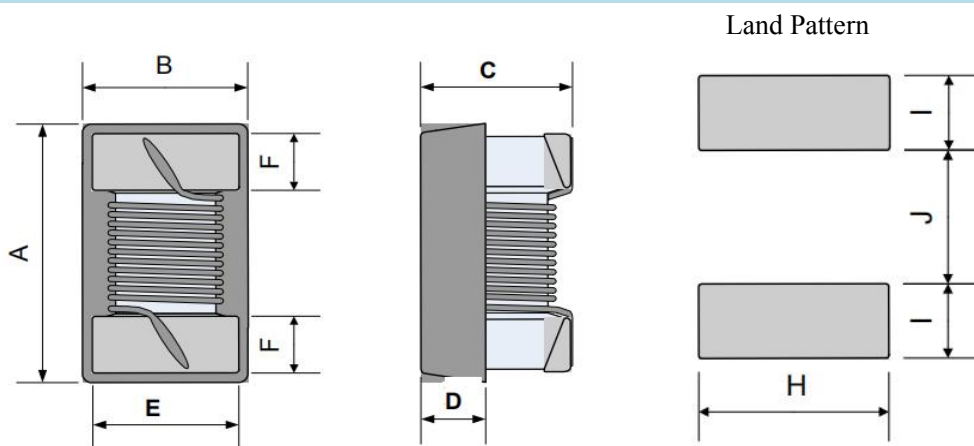
**SHAPE AND DIMENSIONS 外观尺寸**
**RECOMMENDED LAND PATTERN 推荐的焊盘尺寸**

SIZE 尺寸	A Max.	B Max.	C Max.	D Typ.	E Typ.	F Typ.	H Typ.	I Typ.	J Typ.
0603(0201)	0.58	0.46	0.45	0.12	0.38	0.1	0.46	0.18	0.23
1005(0402)	1.19	0.64	0.66	0.20	0.5	0.2	0.65	0.35	0.5
1608(0603)	1.80	1.12	1.02	0.38	0.8	0.3	1.02	0.64	0.64
2012(0805)	2.29	1.73	1.55	0.51	1.27	0.5	1.78	1.02	0.76
2520(1008)	2.92	2.79	2.29	0.51	2.1	0.5	2.54	1.02	1.27
3216(1206)	3.56	2.16	1.52	0.51	1.6	0.5	1.93	1.02	1.78
3225(1210)	3.65	2.95	2.70	0.51	2.1	0.5	3.02	1.02	1.78
4532(1812)	4.95	3.81	3.43	1.78	2.9	0.58	3.05	1.14	3

**STORAGE AND OPERATING CONDITIONS 储存及操作条件**

Operating Temperature Range	-40°C~+125 °C
Storage Temperature and Humidity Range	-10°C~+40°C, 70%RH max.

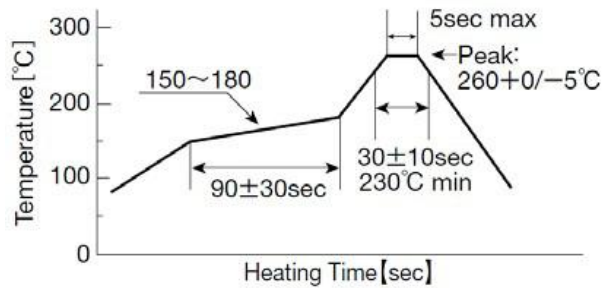
**RECOMMENDED SOLDERING CONDITION 建议焊锡方式**
**REFLOW SOLDERING 回流焊**

1) For reflow soldering with either leaded or lead-free solder, the profile specified in "point for controlling" is recommended.

2) Put the soldering iron on the land-pattern. Soldering iron's temperature-Below 350 °C Duration-3 seconds or less. The soldering iron should not come in contact with inductor directly.

**◆CLEANING**

In the case of ultrasonic cleaning, too much power output can cause excessive vibration of the PC board which may lead to the cracking of the inductor or the soldered portion, or decrease the terminal electrodes' strength. Thus the following conditions should be carefully checked;

Ultrasonic output Below 20W/ℓ

Ultrasonic frequency Below 40kHz

Ultrasonic washing period 5 min. or less

Note:

Washing by supersonic waves shall be avoided for PWCI series.

If washed by supersonic waves, the products might be broken.

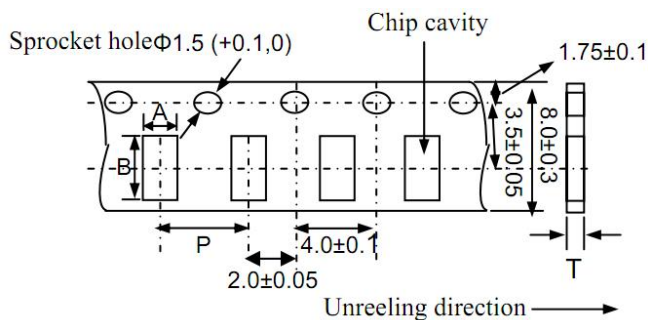
**PACKING STANDARD 包装标准**
**◆Taping Dimensions**
**Paper tape (8mm wide)**

Type	Chip Thickness	A	B	P	T max.	Quantity (pcs/reel)
	(mm)					ø178mm Reel
PWCI0603	0.45	0.47	0.6	2.0	0.65	4000
PWCI1005	0.66	0.75	1.32	2.0	0.90	10000
PWCI1608	1.02	1.17	1.8	4.0	1.17	3000

### Embossed Tape

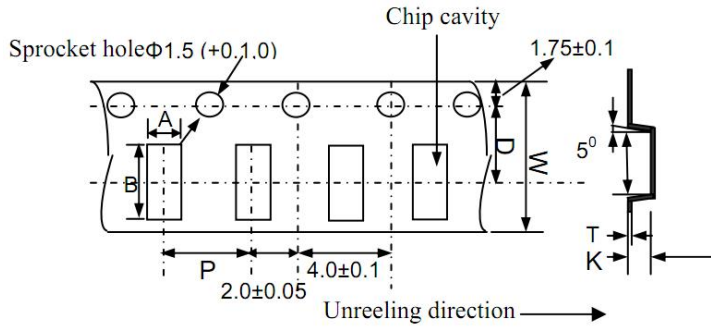

Type	Chip Thickness	W	A	B	D	P	K max.	T max.	Quantity (pcs/reel)
	(mm)								ø178mm
PWCI2012	1.55	8.0	1.88	2.4	3.5	4.0	1.55	0.32	2000
PWCI2520	2.29	8.0	2.73	2.9	3.5	4.0	2.54	0.33	2000
PWCI3216	1.52	12.0	2.4	3.8	5.5	4.0	1.9	0.4	2000
PWCI3225	2.7	8.0	2.96	3.6	3.5	4.0	2.8	0.4	1000
PWCI4532	3.43	12.0	3.61	4.9	5.5	8.0	3.81	0.33	500

### ◆ Reel Dimensions

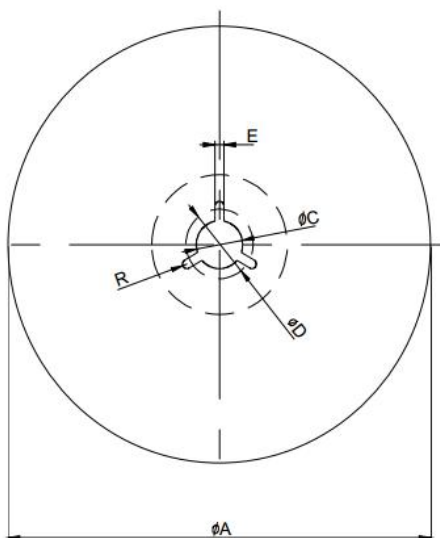

Symbol	ø178mm Reel	Ø330mm Reel
A	Ø178±2	Ø330±2
B	Ø60±2	Ø100±2
C	Ø13±0.8	Ø13±0.8
D	Ø21±0.8	Ø21±0.8
E	2	2
W8	10±1.5	10±1.5
W12	14.5±1.5	14.5±1.5
W16	--	17.4(Typ.)
W24	--	24.4(Typ.)
T	2±0.5	2±0.5
R	1	1



## SPECIFICATIONS 规格特性

## PWCI 0603(0201) TYPE

Part Number 型号	Inductance 电感量 L	Tolerance 公差	Quality Factor 品质因 数 Q	L/Q Test Freq 测试频 率 Freq.	Self-resonant Freq 共振频率 S.R.F	DC Resistance 直流电阻 RDC	Rated Current 额定电 流 Ir
Units 单位	nH	--	--	MHz	GHz	Ω	mA
PWCI0603H0N5□T	0.5	J,K	4	250	23.5	0.02	1250
PWCI0603H0N6□T	0.6	J,K	6	250	24.5	0.03	1000
PWCI0603H1N2□T	1.2	J,K	13	250	17.9	0.042	870
PWCI0603H1N3□T	1.3	J,K	11	250	17.6	0.048	820
PWCI0603H1N4□T	1.4	J,K	14	250	17	0.08	630
PWCI0603H1N5□T	1.5	J,K	11	250	17	0.09	600
PWCI0603H2N2□T	2.2	J,K	15	250	16.7	0.07	700
PWCI0603H2N3□T	2.3	J,K	18	250	16.5	0.07	670
PWCI0603H2N4□T	2.4	J,K	13	250	13	0.082	620
PWCI0603H2N5□T	2.5	J,K	16	250	12.5	0.165	440
PWCI0603H3N3□T	3.3	J,K	14	250	12.8	0.08	630
PWCI0603H3N4□T	3.4	J,K	11	250	12.7	0.08	630
PWCI0603H3N5□T	3.5	J,K	16	250	12.4	0.08	630
PWCI0603H3N6□T	3.6	J,K	18	250	12.5	0.105	550
PWCI0603H3N7□T	3.7	J,K	15	250	10.6	0.105	550
PWCI0603H3N8□T	3.8	J,K	16	250	10.2	0.18	420
PWCI0603H3N9□T	3.9	J,K	12	250	11.2	0.24	360
PWCI0603H4N8□T	4.8	J,K	17	250	11	0.096	570
PWCI0603H4N9□T	4.9	J,K	18	250	11.7	0.13	510
PWCI0603H5N0□T	5	J,K	18	250	11.5	0.13	510
PWCI0603H5N1□T	5.1	J,K	18	250	11.1	0.13	510
PWCI0603H5N2□T	5.2	J,K	18	250	10	0.17	430
PWCI0603H5N3□T	5.3	J,K	18	250	10.6	0.13	510
PWCI0603H5N4□T	5.4	J,K	18	250	10.2	0.13	510
PWCI0603H5N5□T	5.5	J,K	16	250	9.5	0.285	330
PWCI0603H6N7□T	6.7	J,K	18	250	6.8	0.15	460
PWCI0603H6N8□T	6.8	J,K	18	250	9.5	0.15	460
PWCI0603H6N9□T	6.9	J,K	18	250	9.3	0.15	460
PWCI0603H7N0□T	7	J,K	18	250	6.7	0.21	390
PWCI0603H7N1□T	7.1	J,K	18	250	9.5	0.25	390
PWCI0603H7N2□T	7.2	J,K	18	250	9.4	0.25	390
PWCI0603H7N3□T	7.3	J,K	18	250	9.3	0.25	390
PWCI0603H7N4□T	7.4	J,K	18	250	9.1	0.25	390
PWCI0603H7N5□T	7.5	J,K	15	250	6.8	0.34	300



PWCI0603H7N6□T	7.6	J,K	17	250	9.3	0.3	340
PWCI0603H7N7□T	7.7	J,K	17	250	9.2	0.3	340
PWCI0603H7N8□T	7.8	J,K	17	250	9.2	0.3	340
PWCI0603H7N9□T	7.9	J,K	17	250	9.1	0.3	340
PWCI0603H8N0□T	8	J,K	17	250	9.2	0.3	340
PWCI0603H8N1□T	8.1	J,K	17	250	9.1	0.3	340
PWCI0603H8N2□T	8.2	J,K	17	250	6.4	0.27	340
PWCI0603H8N3□T	8.3	J,K	17	250	8.9	0.3	340
PWCI0603H8N4□T	8.4	J,K	15	250	8.9	0.38	300
PWCI0603H8N5□T	8.5	J,K	15	250	8.9	0.38	300
PWCI0603H8N7□T	8.7	J,K	15	250	6.3	0.38	300
PWCI0603H9N0□T	9	J,K	15	250	6.4	0.38	300
PWCI0603H9N4□T	9.4	J,K	16	250	6.4	0.4	280
PWCI0603H9N6□T	9.6	J,K	16	250	6.2	0.4	280
PWCI0603H11N□T	11	J,K	16	250	5.7	0.44	280
PWCI0603H12N□T	12	J,K	17	250	5.6	0.36	300
PWCI0603H13N□T	13	J,K	16	250	6.7	0.5	270
PWCI0603H14N□T	14	J,K	16	250	5.1	0.5	270

**SPECIFICATIONS 规格特性****PWCI 1005(0402) TYPE**

Part Number 型号	Inductance 电感量 L	Tolerance 公差	Quality Factor 品质因 数 Q	L/Q Test Freq 测试频 率 Freq.	Self-resonant Freq 共振频率 S.R.F	DC Resistance 直流电阻 RDC	Rated Current 额定电 流 Ir
Units 单位	nH	--	--	MHz	GHz	Ω	mA
PWCI1005H0N8□T	0.8	C,S,D,K	14	250	>6	0.035	1000
PWCI1005H1N0□T	1.0	C,S,D,K	10	250	>6	0.085	650
PWCI1005H1N8□T	1.8	C,S,D,J,K	20	250	>6	0.043	950
PWCI1005H1N9□T	1.9	C,S,D,J,K	20	250	>6	0.043	950
PWCI1005H2N0□T	2.0	C,S,D,J,K	23	250	>6	0.043	950
PWCI1005H2N2□T	2.2	C,S,D,J,K	22	250	>6	0.058	820
PWCI1005H2N4□T	2.4	C,S,D,J,K	18	250	>6	0.091	650
PWCI1005H2N7□T	2.7	C,S,D,J,K	24	250	>6	0.05	900
PWCI1005H3N0□T	3.0	S,D,K	24	250	>6	0.063	790
PWCI1005H3N3□T	3.3	C,S,D,J,K	24	250	>6	0.063	790
PWCI1005H3N6□T	3.6	C,S,D,J,K	24	250	>6	0.063	790
PWCI1005H3N9□T	3.9	C,S,D,J,K	24	250	>6	0.063	790
PWCI1005H4N1□T	4.1	C,S,D,J,K	22	250	>6	0.07	700
PWCI1005H4N3□T	4.3	C,S,D,J,K	22	250	>6	0.07	750
PWCI1005H4N7□T	4.7	C,S,D,J,K	20	250	>6	0.12	570



PWCI1005H5N1□T	5.1	C,S,D,J,K	23	250	>6	0.1	620
PWCI1005H5N6□T	5.6	C,S,D,J,K	25	250	>6	0.078	710
PWCI1005H5N8□T	5.8	C,S,D,J,K	25	250	>6	0.078	710
PWCI1005H6N2□T	6.2	C,S,D,J,K	25	250	>6	0.078	710
PWCI1005H6N8□T	6.8	G,H,J,K	24	250	6	0.105	610
PWCI1005H7N5□T	7.5	G,H,J,K	25	250	6	0.12	570
PWCI1005H8N2□T	8.2	G,H,J,K	25	250	5.5	0.11	590
PWCI1005H8N7□T	8.7	G,H,J,K	25	250	5.5	0.11	590
PWCI1005H9N0□T	9.0	G,H,J,K	25	250	5.5	0.11	590
PWCI1005H9N1□T	9.1	G,H,J,K	25	250	5.5	0.11	590
PWCI1005H10N□T	10	G,H,J,K	24	250	5.5	0.15	510
PWCI1005H11N□T	11	G,H,J,K	26	250	5.5	0.12	570
PWCI1005H12N□T	12	G,H,J,K	26	250	5.5	0.12	570
PWCI1005H13N□T	13	G,H,J,K	24	250	5	0.18	460
PWCI1005H14N□T	14	G,H,J,K	26	250	5	0.21	430
PWCI1005H15N□T	15	G,H,J,K	26	250	5	0.21	430
PWCI1005H16N□T	16	G,H,J,K	25	250	4.5	0.28	370
PWCI1005H18N□T	18	G,H,J,K	25	250	4.5	0.28	370
PWCI1005H19N□T	19	G,H,J,K	26	250	4	0.24	400
PWCI1005H20N□T	20	G,H,J,K	26	250	4	0.24	400
PWCI1005H22N□T	22	G,H,J,K	25	250	4	0.36	330
PWCI1005H23N□T	23	G,H,J,K	25	250	3.8	0.36	330
PWCI1005H24N□T	24	G,H,J,K	25	250	3.5	0.36	330
PWCI1005H27N□T	27	G,H,J,K	25	250	3.5	0.38	320
PWCI1005H30N□T	30	G,H,J,K	25	250	3.3	0.38	320
PWCI1005H33N□T	33	G,H,J,K	24	250	3.2	0.55	260
PWCI1005H36N□T	36	G,H,J,K	25	250	3.1	0.6	250
PWCI1005H38N□T	38	G,H,J,K	25	250	3	0.6	250
PWCI1005H39N□T	39	G,H,J,K	25	250	3	0.6	250
PWCI1005H43N□T	43	G,H,J,K	25	250	3	0.68	240
PWCI1005H47N□T	47	G,H,J,K	25	250	2.9	0.95	200
PWCI1005H51N□T	51	G,H,J,K	25	250	2.85	0.95	200
PWCI1005H56N□T	56	G,H,J,K	25	250	2.8	1.05	190
PWCI1005H62N□T	62	G,H,J,K	25	250	2.6	1.05	190
PWCI1005H68N□T	68	G,H,J,K	25	250	2.5	1.35	170
PWCI1005H75N□T	75	G,H,J,K	24	250	2.4	1.75	140
PWCI1005H82N□T	82	G,H,J,K	25	250	2.3	1.95	140
PWCI1005H91N□T	91	G,H,J,K	25	250	2.1	2.06	140
PWCI1005H96N□T	96	G,H,J,K	24	250	1.5	2.06	130
PWCI1005HR10□T	100	G,H,J,K	24	250	1.5	2.06	130





PWCI1005HR11□T	110	G,H,J,K	25	250	1.2	2.38	120
PWCI1005HR12□T	120	J,K	25	250	1	2.66	110
PWCI1005HR18□T	180	J,K	8	250	0.7	2.7	50
PWCI1005HR22□T	220	J,K	8	250	0.7	4	50

**SPECIFICATIONS 规格特性****PWCI 1608(0603) TYPE**

Part Number 型号	Inductance 电感量 L	Tolerance 公差	Quality Factor 品质因 数 Q	L/Q Test Freq 测试频 率 Freq.	Self-resonant Freq 共振频率 S.R.F	DC Resistance 直流电阻 RDC	Rated Current 额定电 流 Ir
Units 单位	nH	--	--	MHz	GHz	Ω	mA
PWCI1608H1N6□T	1.6	S,K	22	250	>6	0.035	1150
PWCI1608H1N7□T	1.7	C,S,D,J,K	16	250	>6	0.043	1000
PWCI1608H1N8□T	1.8	C,S,D,J,K	18	250	>6	0.043	1000
PWCI1608H2N2□T	2.2	S,D,K	13	250	>6	0.15	700
PWCI1608H2N7□T	2.7	C,S,D,J,K	25	250	>6	0.043	1000
PWCI1608H3N3□T	3.3	C,S,D,J,K	25	250	>6	0.059	850
PWCI1608H3N6□T	3.6	C,S,D,J,K	25	250	>6	0.059	850
PWCI1608H3N9□T	3.9	C,S,D,J,K	25	250	>6	0.059	850
PWCI1608H4N3□T	4.3	C,S,D,J,K	25	250	>6	0.059	850
PWCI1608H4N7□T	4.7	C,S,D,J,K	25	250	>6	0.065	800
PWCI1608H5N1□T	5.1	C,S,D,J,K	21	250	>6	0.13	600
PWCI1608H6N2□T	6.2	C,S,D,J,K	29	250	>6	0.095	700
PWCI1608H6N8□T	6.8	G,H,J,K	29	250	>6	0.095	700
PWCI1608H7N5□T	7.5	G,H,J,K	33	250	>6	0.095	700
PWCI1608H8N2□T	8.2	G,H,J,K	31	250	>6	0.095	700
PWCI1608H8N7□T	8.7	G,H,J,K	31	250	>6	0.095	700
PWCI1608H9N1□T	9.1	G,H,J,K	30	250	6	0.12	620
PWCI1608H9N5□T	9.5	G,H,J,K	26	250	6	0.16	540
PWCI1608H10N□T	10	G,H,J,K	30	250	6	0.13	600
PWCI1608H11N□T	11	G,H,J,K	35	250	6	0.13	600
PWCI1608H12N□T	12	G,H,J,K	35	250	6	0.13	600
PWCI1608H13N□T	13	G,H,J,K	35	250	6	0.13	600
PWCI1608H15N□T	15	G,H,J,K	37	250	6	0.15	550
PWCI1608H16N□T	16	G,H,J,K	37	250	5.5	0.15	550
PWCI1608H17N□T	17	G,H,J,K	37	250	5.5	0.15	550
PWCI1608H18N□T	18	G,H,J,K	37	250	5.5	0.15	550
PWCI1608H20N□T	20	G,H,J,K	37	250	4.9	0.15	550
PWCI1608H22N□T	22	G,H,J,K	38	250	4.6	0.19	490
PWCI1608H23N□T	23	G,H,J,K	40	250	3.8	0.19	490



PWCI1608H24N□T	24	G,H,J,K	40	250	3.8	0.19	490
PWCI1608H25N□T	25	G,H,J,K	40	250	3.7	0.19	490
PWCI1608H27N□T	27	G,H,J,K	38	250	3.7	0.19	490
PWCI1608H30N□T	30	G,H,J,K	38	250	3.3	0.21	470
PWCI1608H33N□T	33	G,H,J,K	40	250	3.2	0.21	470
PWCI1608H36N□T	36	G,H,J,K	40	250	2.9	0.22	460
PWCI1608H39N□T	39	G,H,J,K	40	250	2.8	0.22	460
PWCI1608H43N□T	43	G,H,J,K	40	250	2.7	0.27	400
PWCI1608H47N□T	47	G,H,J,K	36	200	2.6	0.27	400
PWCI1608H51N□T	51	G,H,J,K	35	200	2.4	0.3	390
PWCI1608H56N□T	56	G,H,J,K	38	200	2.4	0.35	360
PWCI1608H62N□T	62	G,H,J,K	36	200	2.3	0.38	350
PWCI1608H68N□T	68	G,H,J,K	36	200	2.2	0.38	350
PWCI1608H72N□T	72	G,H,J,K	34	150	2.1	0.43	320
PWCI1608H82N□T	82	G,H,J,K	34	150	2	0.5	300
PWCI1608H90N□T	90	G,H,J,K	34	150	1.9	0.52	300
PWCI1608H91N□T	91	G,H,J,K	34	150	1.9	0.52	300
PWCI1608HR10□T	100	G,H,J,K	31	150	1.8	0.66	260
PWCI1608HR11□T	110	G,H,J,K	32	150	1.7	0.73	250
PWCI1608HR12□T	120	G,H,J,K	32	150	1.6	0.75	240
PWCI1608HR13□T	130	G,H,J,K	32	150	1.5	0.75	240
PWCI1608HR14□T	140	G,H,J,K	32	150	1.4	1.1	200
PWCI1608HR15□T	150	G,H,J,K	32	150	1.4	1.12	200
PWCI1608HR16□T	160	G,H,J,K	32	150	1.4	1.12	200
PWCI1608HR18□T	180	G,H,J,K	25	100	1.3	1.38	180
PWCI1608HR20□T	200	G,H,J,K	25	100	1.25	1.9	150
PWCI1608HR21□T	210	G,H,J,K	25	100	1.25	1.9	150
PWCI1608HR22□T	220	G,H,J,K	25	100	1.2	2.1	140
PWCI1608HR24□T	240	G,H,J,K	25	100	1.1	2.75	120
PWCI1608HR25□T	250	G,H,J,K	25	100	1.1	2.8	120
PWCI1608HR27□T	270	G,H,J,K	26	100	0.96	3	120
PWCI1608HR30□T	300	G,H,J,K	26	100	0.9	4.05	110
PWCI1608HR33□T	330	G,H,J,K	26	100	0.8	4.2	100
PWCI1608HR39□T	390	G,H,J,K	27	100	0.8	4.5	100
PWCI1608HR42□T	420	G,H,J,K	27	100	0.8	5.4	90
PWCI1608HR47□T	470	G,H,J,K	27	100	0.7	5.7	90
PWCI1608HR56□T	560	G,H,J,K	27	100	0.65	8.1	70



## SPECIFICATIONS 规格特性

## PWCI 2012(0805) TYPE

Part Number 型号	Inductance 电感量 L	Tolerance 公差	Quality Factor 品质因 数 Q	L/Q Test Freq 测试频 率 Freq. L/Q	Self-resonant Freq 共振频率 S.R.F	DC Resistance 直流电阻 RDC	Rated Current 额定电 流 Ir
Units 单位	nH	--	--	MHz	GHz	Ω	mA
PWCI2012H2N2□T	2.2	G,H,J,K	40	250/1500	>6	0.10	600
PWCI2012H3N3□T	3.3	G,H,J,K	25	250/1500	>6	0.20	600
PWCI2012H6N8□T	6.8	G,H,J,K	40	250/1000	5	0.11	600
PWCI2012H8N2□T	8.2	G,H,J,K	40	250/1000	4.6	0.19	600
PWCI2012H12N□T	12	G,H,J,K	40	250/500	4	0.15	600
PWCI2012H15N□T	15	G,H,J,K	40	250/500	2.9	0.17	600
PWCI2012H18N□T	18	G,H,J,K	50	250/500	3.3	0.20	600
PWCI2012H22N□T	22	G,H,J,K	55	250/500	2	0.22	500
PWCI2012H27N□T	27	G,H,J,K	55	250/500	2.5	0.25	500
PWCI2012H33N□T	33	G,H,J,K	60	250/500	2	0.27	500
PWCI2012H39N□T	39	G,H,J,K	60	250/500	2	0.29	500
PWCI2012H47N□T	47	G,H,J,K	60	200/500	1.6	0.31	500
PWCI2012H56N□T	56	G,H,J,K	55	200/500	1.55	0.32	500
PWCI2012H68N□T	68	G,H,J,K	55	200/500	1.45	0.38	500
PWCI2012H82N□T	82	G,H,J,K	50	150/500	1.3	0.42	400
PWCI2012HR10□T	100	G,H,J,K	50	150/500	1.2	0.46	400
PWCI2012HR12□T	120	G,H,J,K	50	150/250	1.1	0.51	400
PWCI2012HR15□T	150	G,H,J,K	50	100/250	0.92	0.56	400
PWCI2012HR18□T	180	G,H,J,K	50	100/250	0.87	0.64	400
PWCI2012HR22□T	220	G,H,J,K	45	100/250	0.85	1.10	400
PWCI2012HR27□T	270	G,H,J,K	38	100/250	0.65	1.00	350
PWCI2012HR33□T	330	G,H,J,K	40	100/250	0.6	1.40	310
PWCI2012HR39□T	390	G,H,J,K	35	100/250	0.56	1.50	290
PWCI2012HR47□T	470	G,H,J,K	33	50/100	0.375	1.72	250
PWCI2012HR56□T	560	G,H,J,K	23	25/50	0.32	1.90	230
PWCI2012HR62□T	620	G,H,J,K	23	25/50	0.28	1.95	200
PWCI2012HR68□T	680	G,H,J,K	23	25/50	0.27	2.05	190
PWCI2012HR75□T	750	G,H,J,K	23	25/50	0.24	2.10	180
PWCI2012HR82□T	820	G,H,J,K	23	25/50	0.25	2.30	180
PWCI2012HR91□T	910	G,H,J,K	22	25/50	0.23	2.40	160
PWCI2012H1R0□T	1000	G,H,J,K	20	25/50	0.2	2.50	150
PWCI2012H1R2□T	1200	J,K	15	7.9/7.9	0.2	2.38	150
PWCI2012H1R5□T	1500	J,K	15	7.9/7.9	0.2	2.90	130



PWCI2012H1R8□T	1800	J,K	15	7.9/7.9	0.12	3.00	120
PWCI2012H2R2□T	2200	J,K	15	7.9/7.9	0.11	3.10	110
PWCI2012H2R7□T	2700	J,K	15	7.9/7.9	0.1	3.50	100
PWCI2012H3R3□T	3300	J,K	15	7.9/7.9	0.07	2.30	210
PWCI2012H3R9□T	3900	J,K	15	7.9/7.9	0.06	2.50	200
PWCI2012H4R7□T	4700	J,K	15	7.9/7.9	0.05	2.80	180
PWCI2012H5R6□T	5600	J,K	15	7.9/7.9	0.045	3.00	160
PWCI2012H6R8□T	6800	J,K	15	7.9/7.9	0.045	3.20	130
PWCI2012H8R2□T	8200	J,K	15	7.9/7.9	0.04	3.50	120
PWCI2012H100□T	10000	J,K	15	2.5/2.5	0.04	5.00	80

**SPECIFICATIONS 规格特性****PWCI 2520(1008) TYPE**

Part Number 型号	Inductance 电感量 L	Tolerance 公差	Quality Factor 品质因 数 Q	L/Q Test Freq 测试频 率 Freq. L/Q	Self-resonant Freq 共振频率 S.R.F	DC Resistance 直流电阻 RDC	Rated Current 额定电 流 Ir
Units 单位	nH	--	--	MHz	GHz	Ω	mA
PWCI2520H4N7□T	4.7	G,H,J,K	50	50/1500	>6	0.11	1000
PWCI2520H10N□T	10	G,H,J,K	50	50/500	4.1	0.08	1000
PWCI2520H12N□T	12	G,H,J,K	50	50/500	3.3	0.09	1000
PWCI2520H15N□T	15	G,H,J,K	50	50/500	2.5	0.13	1000
PWCI2520H18N□T	18	G,H,J,K	50	50/350	2.5	0.11	1000
PWCI2520H22N□T	22	G,H,J,K	55	50/350	2.4	0.12	1000
PWCI2520H27N□T	27	G,H,J,K	55	50/350	1.6	0.13	1000
PWCI2520H33N□T	33	G,H,J,K	60	50/350	1.6	0.14	1000
PWCI2520H39N□T	39	G,H,J,K	50	50/350	1.5	0.15	1000
PWCI2520H47N□T	47	G,H,J,K	65	50/350	1.5	0.16	1000
PWCI2520H56N□T	56	G,H,J,K	50	50/350	1.3	0.18	1000
PWCI2520H68N□T	68	G,H,J,K	65	50/350	1.2	0.21	1000
PWCI2520H82N□T	82	G,H,J,K	60	50/350	0.8	0.22	1000
PWCI2520HR10□T	100	G,H,J,K	60	25/350	1	0.56	650
PWCI2520HR12□T	120	G,H,J,K	60	25/350	0.95	0.63	650
PWCI2520HR15□T	150	G,H,J,K	50	25/100	0.8	0.62	580
PWCI2520HR18□T	180	G,H,J,K	50	25/100	0.75	0.70	620
PWCI2520HR22□T	220	G,H,J,K	50	25/100	0.63	0.80	500
PWCI2520HR27□T	270	G,H,J,K	50	25/100	0.6	0.91	500
PWCI2520HR33□T	330	G,H,J,K	50	25/100	0.53	1.05	450
PWCI2520HR39□T	390	G,H,J,K	50	25/100	0.48	1.12	470
PWCI2520HR47□T	470	G,H,J,K	50	25/100	0.45	1.19	470



PWCI2520HR56□T	560	G,H,J,K	50	25/100	0.39	1.33	400
PWCI2520HR62□T	620	G,H,J,K	45	25/100	0.375	1.40	300
PWCI2520HR68□T	680	G,H,J,K	45	25/100	0.36	1.47	400
PWCI2520HR75□T	750	G,H,J,K	45	25/100	0.36	1.54	360
PWCI2520HR82□T	820	G,H,J,K	45	25/100	0.33	1.61	400
PWCI2520HR91□T	910	G,H,J,K	35	25/50	0.295	1.68	380
PWCI2520H1R0□T	1000	G,H,J,K	35	25/50	0.27	1.80	370
PWCI2520H1R2□T	1200	G,H,J,K	35	7.9/50	0.2	2.00	310
PWCI2520H1R5□T	1500	G,H,J,K	28	7.9/50	0.15	2.30	330
PWCI2520H1R8□T	1800	G,H,J,K	28	7.9/50	0.12	2.60	300
PWCI2520H2R2□T	2200	G,H,J,K	28	7.9/50	0.1	2.80	280
PWCI2520H2R7□T	2700	G,H,J,K	22	7.9/25	0.09	3.20	290
PWCI2520H3R3□T	3300	G,H,J,K	22	7.9/25	0.07	3.40	290
PWCI2520H3R9□T	3900	G,H,J,K	20	7.9/25	0.06	3.60	260
PWCI2520H4R7□T	4700	G,H,J,K	20	7.9/25	0.05	4.00	260
PWCI2520H5R6□T	5600	G,H,J,K	20	7.9/25	0.04	5.70	240
PWCI2520H6R8□T	6800	G,H,J,K	20	7.9/25	0.04	7.70	200
PWCI2520H8R2□T	8200	G,H,J,K	20	7.9/25	0.03	10.7	150
PWCI2520H100□T	10000	J,K	15	2.5	0.033	3.50	150
PWCI2520H120□T	12000	J,K	20	2.5	0.03	3.60	140
PWCI2520H150□T	15000	J,K	20	2.5	0.026	4.00	130
PWCI2520H180□T	18000	J,K	20	2.5	0.024	4.50	120
PWCI2520H220□T	22000	J,K	20	2.5	0.022	4.80	110
PWCI2520H270□T	27000	J,K	20	2.5	0.021	5.30	95
PWCI2520H330□T	33000	J,K	20	2.5	0.02	6.10	85
PWCI2520H390□T	39000	J,K	20	2.5	0.018	8.30	60
PWCI2520H470□T	47000	J,K	20	2.5	0.017	12.0	45

**SPECIFICATIONS 规格特性****PWCI 3216(1206) TYPE**

Part Number 型号	Inductance 电感量 L	Tolerance 公差	Quality Factor 品质因 数 Q	L/Q Test Freq 测试频 率 Freq.	Self-resonant Freq 共振频率 S.R.F	DC Resistance 直流电阻 RDC	Rated Current 额定电 流 Ir
Units 单位	nH	--	--	MHz	GHz	Ω	mA
PWCI3216H3N3□T	3.3	G,H,J,K	20	100/300	6.2	0.07	1000
PWCI3216H6N8□T	6.8	G,H,J,K	30	100/300	5.5	0.07	1000
PWCI3216H10N□T	10	G,H,J,K	40	100/300	4.0	0.09	1000
PWCI3216H12N□T	12	G,H,J,K	40	100/300	3.2	0.09	1000
PWCI3216H15N□T	15	G,H,J,K	40	100/300	3.2	0.12	1000
PWCI3216H18N□T	18	G,H,J,K	45	100/300	2.8	0.12	1000



PWCI3216H22N□T	22	G,H,J,K	50	100/300	2.2	0.12	1000
PWCI3216H27N□T	27	G,H,J,K	50	100/300	1.8	0.12	1000
PWCI3216H33N□T	33	G,H,J,K	50	100/300	1.8	0.12	1000
PWCI3216H39N□T	39	G,H,J,K	50	100/300	1.8	0.12	1000
PWCI3216H47N□T	47	G,H,J,K	50	100/300	1.5	0.13	1000
PWCI3216H56N□T	56	G,H,J,K	55	100/300	1.45	0.14	1000
PWCI3216H68N□T	68	G,H,J,K	55	100/300	1.2	0.26	900
PWCI3216H82N□T	82	G,H,J,K	55	100/300	1.2	0.21	900
PWCI3216HR10□T	100	G,H,J,K	55	100/300	1.1	0.30	850
PWCI3216HR12□T	120	G,H,J,K	60	100/300	1.1	0.30	800
PWCI3216HR15□T	150	G,H,J,K	55	100/300	0.95	0.31	750
PWCI3216HR18□T	180	G,H,J,K	60	50/300	0.9	0.43	700
PWCI3216HR22□T	220	G,H,J,K	60	50/300	0.76	0.56	670
PWCI3216HR27□T	270	G,H,J,K	50	50/300	0.73	0.56	630
PWCI3216HR33□T	330	G,H,J,K	45	50/150	0.65	0.70	590
PWCI3216HR39□T	390	G,H,J,K	45	50/150	0.6	0.80	530
PWCI3216HR47□T	470	G,H,J,K	45	50/150	0.55	1.30	490
PWCI3216HR56□T	560	G,H,J,K	45	35/150	0.47	1.34	460
PWCI3216HR68□T	680	G,H,J,K	45	35/150	0.45	1.58	430
PWCI3216HR82□T	820	G,H,J,K	45	35/150	0.42	1.82	400
PWCI3216H1R0□T	1000	G,H,J,K	45	35/150	0.4	2.80	320
PWCI3216H1R2□T	1200	G,H,J,K	45	35/150	0.38	3.20	300

**SPECIFICATIONS 规格特性****PWCI 3225(1210) TYPE**

Part Number 型号	Inductance 电感量 L	Tolerance 公差	Quality Factor 品质因 数 Q	L/Q Test Freq 测试频 率 Freq.	Self-resonant Freq 共振频率 S.R.F	DC Resistance 直流电阻 RDC	Rated Current 额定电 流 Ir
Units 单位	nH	--	--	MHz	GHz	Ω	mA
PWCI3225H3N9□T	3.9	G,H,J,K	30	100/300	6	0.05	1000
PWCI3225H4N7□T	4.7	G,H,J,K	30	100/300	5.8	0.065	1000
PWCI3225H8N2□T	8.2	G,H,J,K	30	100/300	5.5	0.07	1000
PWCI3225H10N□T	10	G,H,J,K	40	100/300	4	0.08	1000
PWCI3225H12N□T	12	G,H,J,K	40	100/300	3.2	0.08	1000
PWCI3225H15N□T	15	G,H,J,K	40	100/300	3.2	0.10	1000
PWCI3225H18N□T	18	G,H,J,K	50	100/300	2.8	0.10	1000
PWCI3225H22N□T	22	G,H,J,K	50	100/300	2.2	0.10	1000
PWCI3225H27N□T	27	G,H,J,K	50	100/300	1.8	0.11	1000
PWCI3225H33N□T	33	G,H,J,K	55	100/300	1.8	0.11	1000
PWCI3225H39N□T	39	G,H,J,K	55	100/300	1.5	0.12	1000



PWCI3225H43N□T	43	G,H,J,K	55	100/300	1.5	0.12	1000
PWCI3225H47N□T	47	G,H,J,K	55	100/300	1.5	0.13	1000
PWCI3225H56N□T	56	G,H,J,K	55	100/300	1.45	0.14	1000
PWCI3225H68N□T	68	G,H,J,K	55	100/300	1.2	0.15	900
PWCI3225H82N□T	82	G,H,J,K	55	100/300	1	0.20	900
PWCI3225HR10□T	100	G,H,J,K	55	100/300	0.9	0.20	850
PWCI3225HR12□T	120	G,H,J,K	60	100/300	0.8	0.25	800
PWCI3225HR15□T	150	G,H,J,K	60	100/300	0.7	0.25	750
PWCI3225HR18□T	180	G,H,J,K	60	50/300	0.65	0.30	700
PWCI3225HR22□T	220	G,H,J,K	60	50/300	0.65	0.40	770
PWCI3225HR27□T	270	G,H,J,K	40	50/300	0.58	0.40	630
PWCI3225HR33□T	330	G,H,J,K	45	50/150	0.58	0.58	590
PWCI3225HR39□T	390	G,H,J,K	45	50/150	0.51	0.58	530
PWCI3225HR47□T	470	G,H,J,K	45	50/150	0.48	0.80	490
PWCI3225HR56□T	560	G,H,J,K	45	35/150	0.42	1.10	460
PWCI3225HR68□T	680	G,H,J,K	45	35/150	0.4	1.20	430
PWCI3225HR82□T	820	G,H,J,K	45	35/150	0.37	1.82	400
PWCI3225H1R0□T	1000	G,H,J,K	45	35/150	0.34	1.85	320
PWCI3225H1R2□T	1200	G,H,J,K	35	35/150	0.22	1.87	300
PWCI3225H1R5□T	1500	G,H,J,K	20	7.9/50	0.16	1.95	310
PWCI3225H1R8□T	1800	G,H,J,K	30	7.9/50	0.16	2.25	310
PWCI3225H2R2□T	2200	G,H,J,K	25	7.9/50	0.13	2.41	310
PWCI3225H2R7□T	2700	G,H,J,K	25	7.9/50	0.11	2.85	300
PWCI3225H3R3□T	3300	G,H,J,K	20	7.9/25	0.11	3.12	300
PWCI3225H3R9□T	3900	G,H,J,K	20	7.9/25	0.06	3.60	290
PWCI3225H4R7□T	4700	G,H,J,K	20	7.9/25	0.06	4.00	280
PWCI3225H5R6□T	5600	G,H,J,K	15	7.9/25	0.05	5.00	250
PWCI3225H6R8□T	6800	G,H,J,K	15	7.9/7.9	0.04	8.00	230
PWCI3225H8R6□T	8600	G,H,J,K	15	7.9/7.9	0.04	9.00	200

**SPECIFICATIONS 规格特性****PWCI 4532(1812) TYPE**

Part Number 型号	Inductance 电感量 L	Tolerance 公差	Quality Factor 品质因 数 Q	L/Q Test Freq 测试频 率 Freq.	Self-resonant Freq 共振频率 S.R.F	DC Resistance 直流电阻 RDC	Rated Current 额定电 流 Ir
Units 单位	nH	--	--	MHz	GHz	Ω	mA
PWCI4532H1R0□T	1000	G,H,J,K	60	7.9/50	0.25	1.2	480
PWCI4532H1R2□T	1200	G,H,J,K	60	7.9/50	0.23	1.2	480
PWCI4532H1R5□T	1500	G,H,J,K	60	7.9/50	0.21	1.6	430
PWCI4532H1R8□T	1800	G,H,J,K	55	7.9/50	0.15	2.0	380

PWCI4532H2R2□T	2200	G,H,J,K	55	7.9/50	0.15	2.2	340
PWCI4532H2R7□T	2700	G,H,J,K	55	7.9/50	0.15	3.2	300
PWCI4532H3R3□T	3300	G,H,J,K	55	7.9/50	0.13	3.8	270
PWCI4532H3R9□T	3900	G,H,J,K	55	7.9/50	0.12	5.0	240
PWCI4532H4R7□T	4700	G,H,J,K	55	7.9/50	0.09	5.4	230
PWCI4532H5R6□T	5600	G,H,J,K	45	7.9/50	0.09	5.7	220
PWCI4532H6R8□T	6800	G,H,J,K	30	7.9/50	0.08	6.6	210
PWCI4532H8R2□T	8200	G,H,J,K	20	7.9/50	0.07	7.0	200
PWCI4532H100□T	10000	G,H,J,K	15	7.9/50	0.06	7.7	190
PWCI4532H120□T	12000	G,H,J,K	30	2.5/10	0.05	8.7	180
PWCI4532H150□T	15000	G,H,J,K	30	2.5/10	0.03	9.6	170
PWCI4532H180□T	18000	G,H,J,K	25	2.5/10	0.03	10.5	160
PWCI4532H220□T	22000	G,H,J,K	25	2.5/10	0.02	11.5	155
PWCI4532H270□T	27000	G,H,J,K	25	2.5/10	0.02	12.5	150
PWCI4532H330□T	33000	G,H,J,K	10	2.5/10	0.01	13.5	145

## TYPICAL ELECTRICAL CHARACTERISTICS 典型电气特性

### INDUCTANCE vs. FREQUENCY

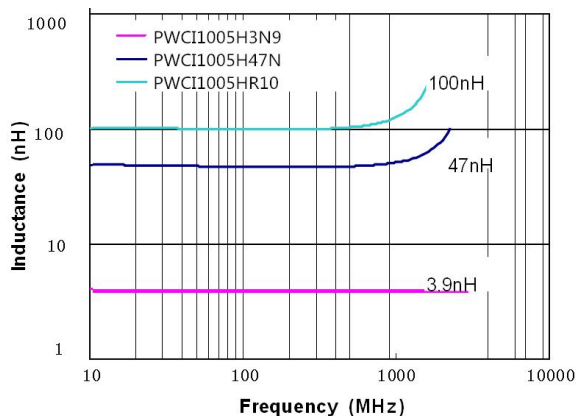
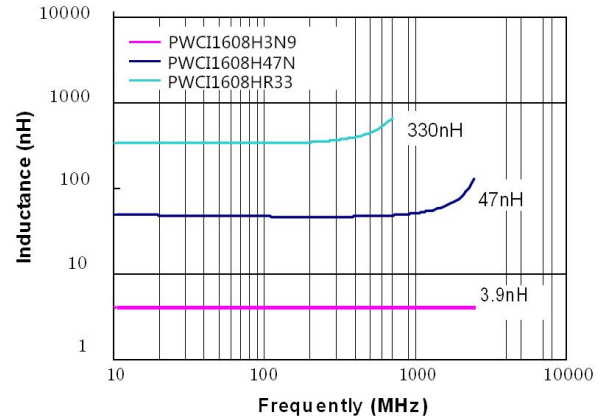
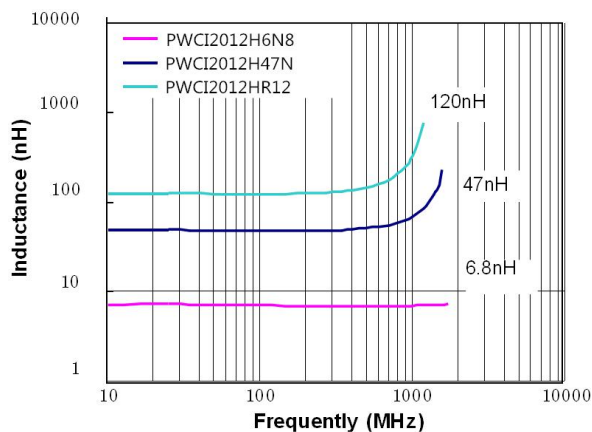
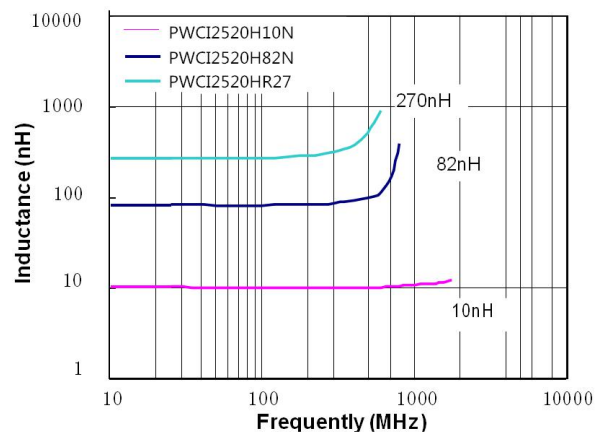
**PWCI 1005(0402) TYPE**

**PWCI 1608(0603) TYPE**

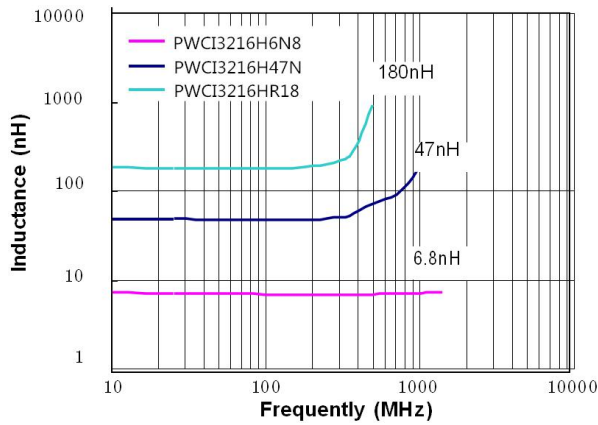
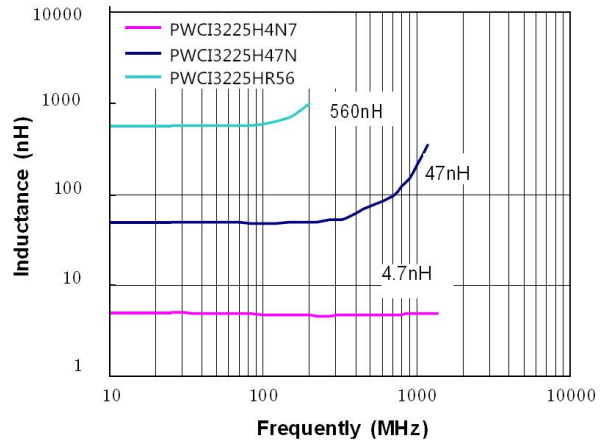
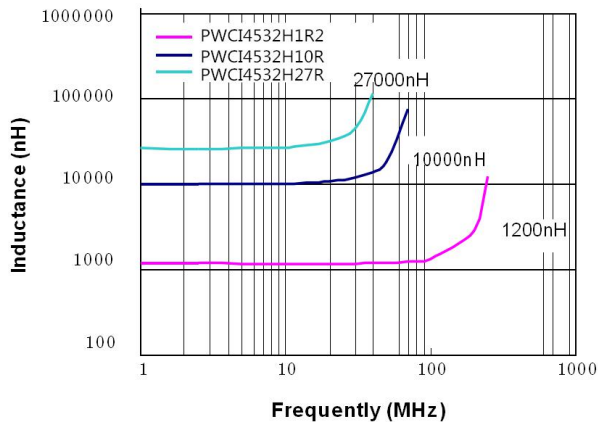
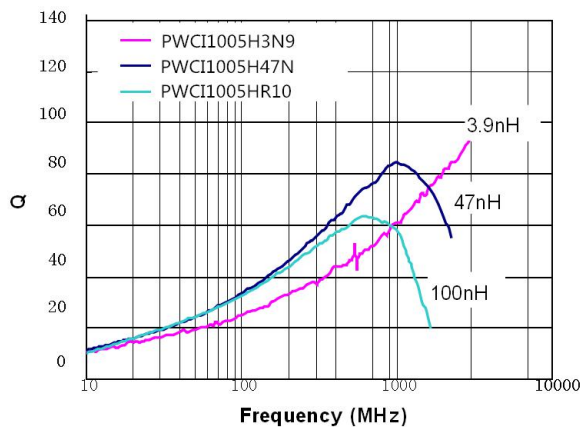
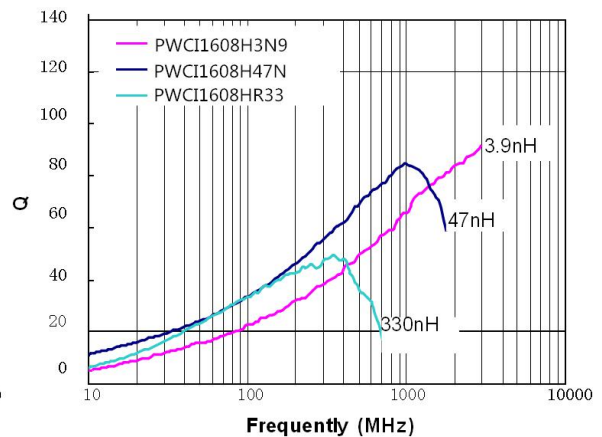
**PWCI 2012(0805) TYPE**

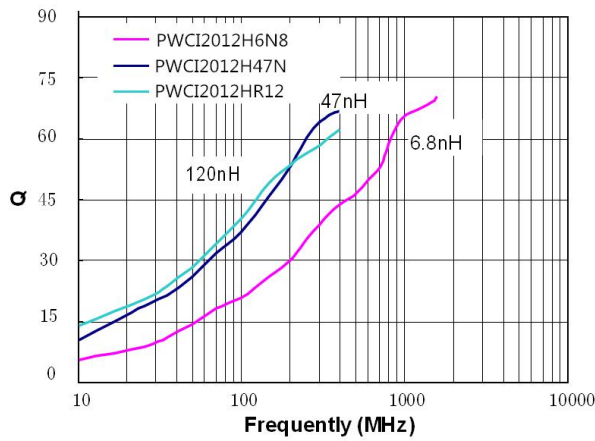
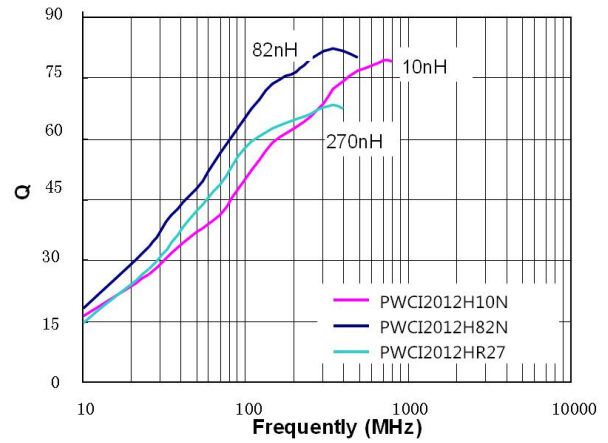
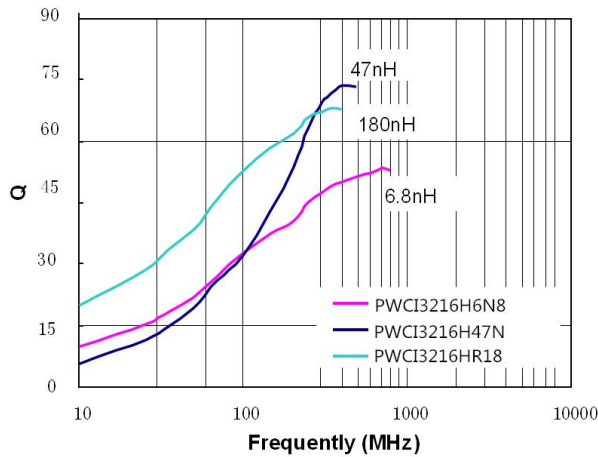
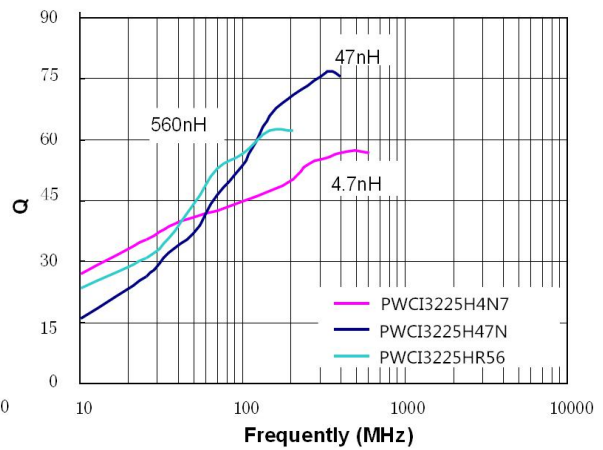
**PWCI 2520(1008) TYPE**



**TYPICAL ELECTRICAL CHARACTERISTICS 典型电气特性**
**INDUCTANCE vs. FREQUENCY**
**PWCI 3216(1206) TYPE**

**PWCI 3225(1210) TYPE**

**PWCI 4532(1812) TYPE**

**TYPICAL ELECTRICAL CHARACTERISTICS 典型电气特性**
**Q vs. FREQUENCY**
**PWCI 1005(0402) TYPE**

**PWCI 1608(0603) TYPE**

**TYPICAL ELECTRICAL CHARACTERISTICS 典型电气特性**
**Q vs. FREQUENCY**
**PWCI 2012(0805) TYPE**

**PWCI 2520(1008) TYPE**

**PWCI 3216(1206) TYPE**

**PWCI 3225(1210) TYPE**

**PWCI 4532(1812) TYPE**
